

Richard / 170 / 17

Richard//70/17
Grundplan

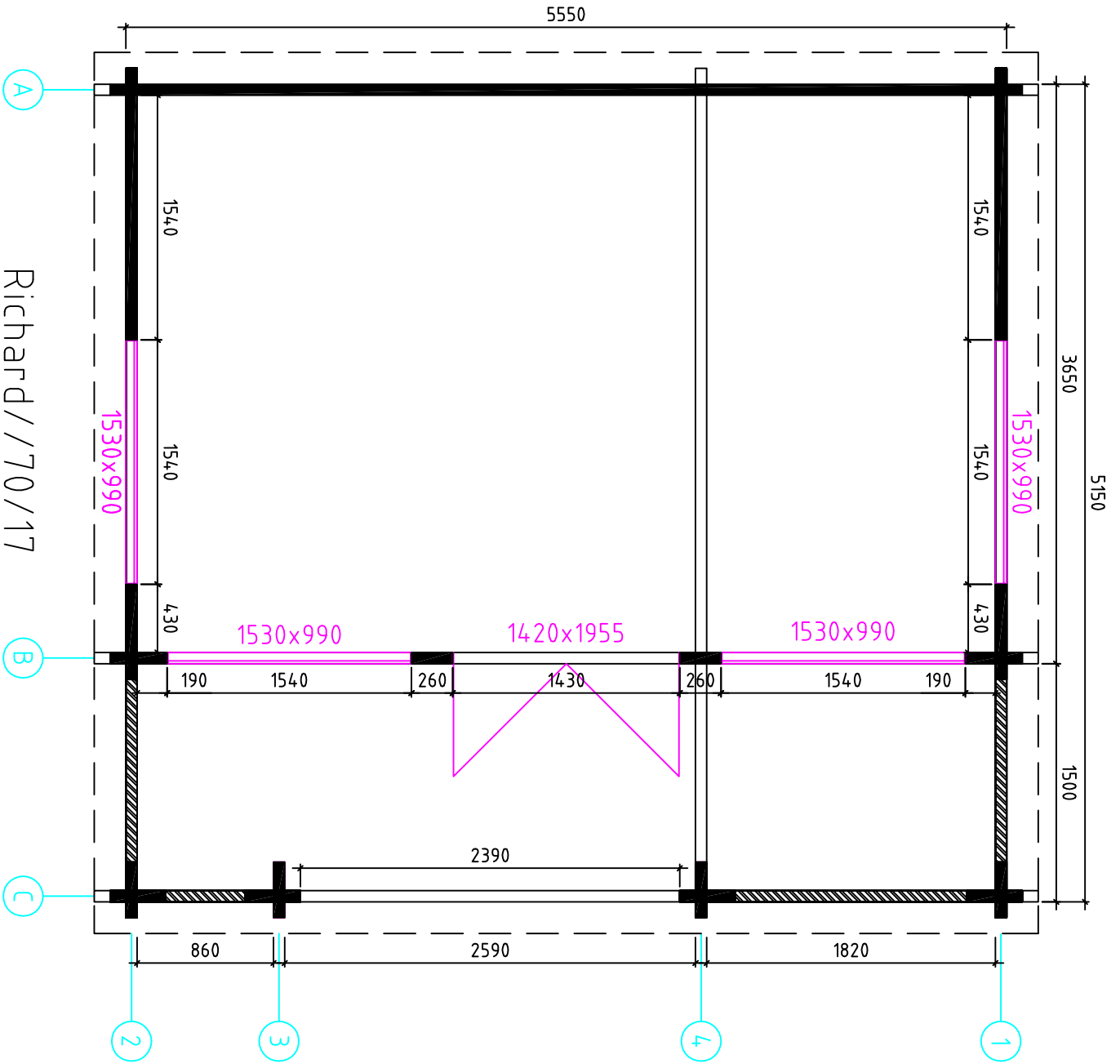

Schrauben
6x150

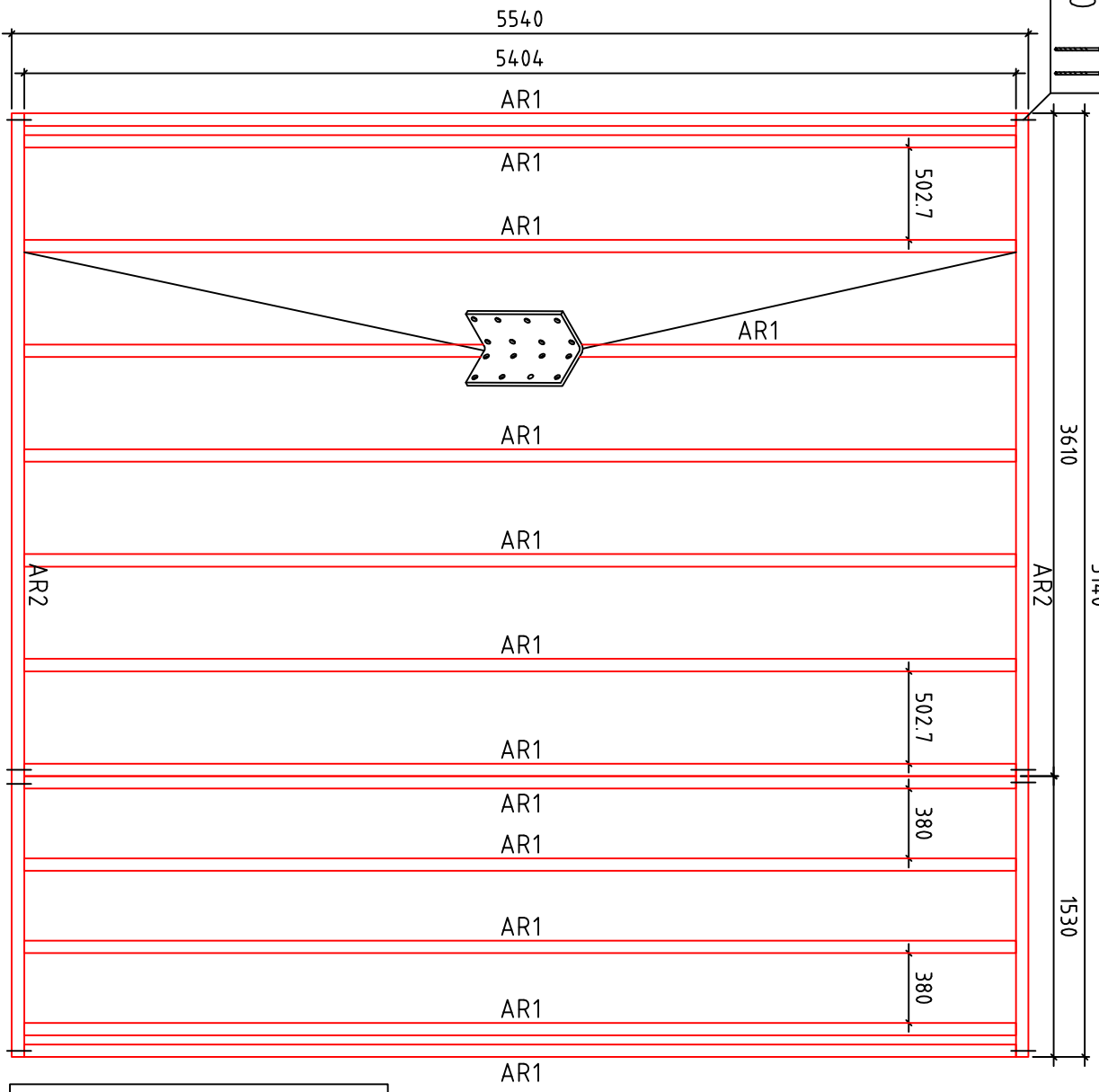

Richard//70/17
Fundament

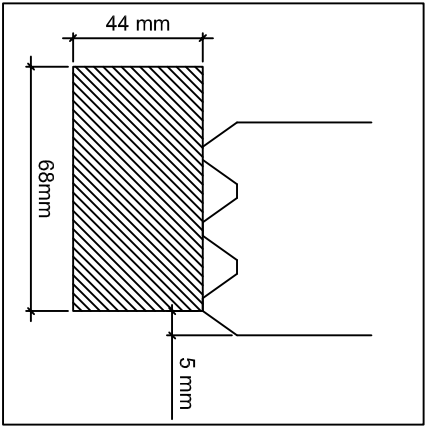

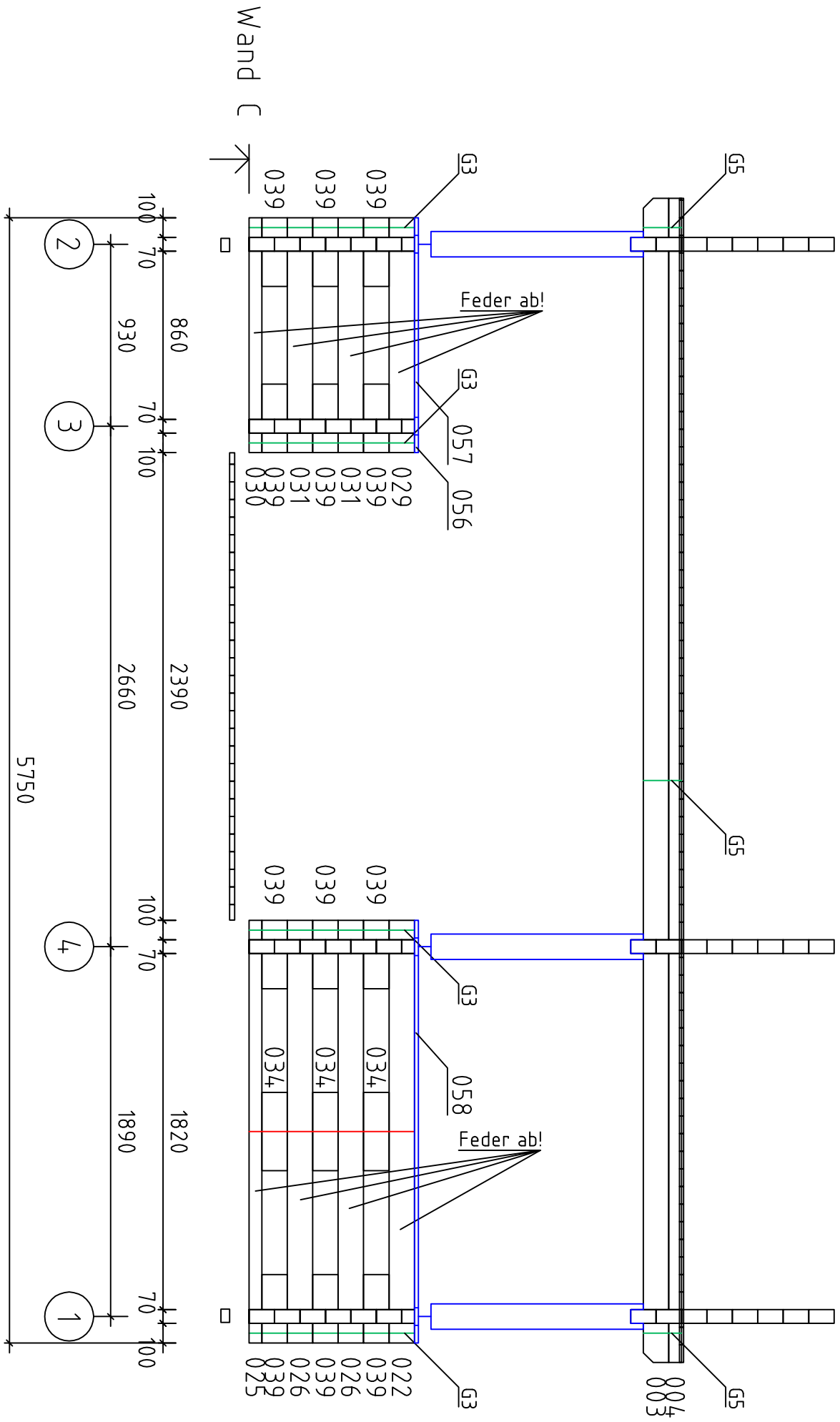

Richard//70/17

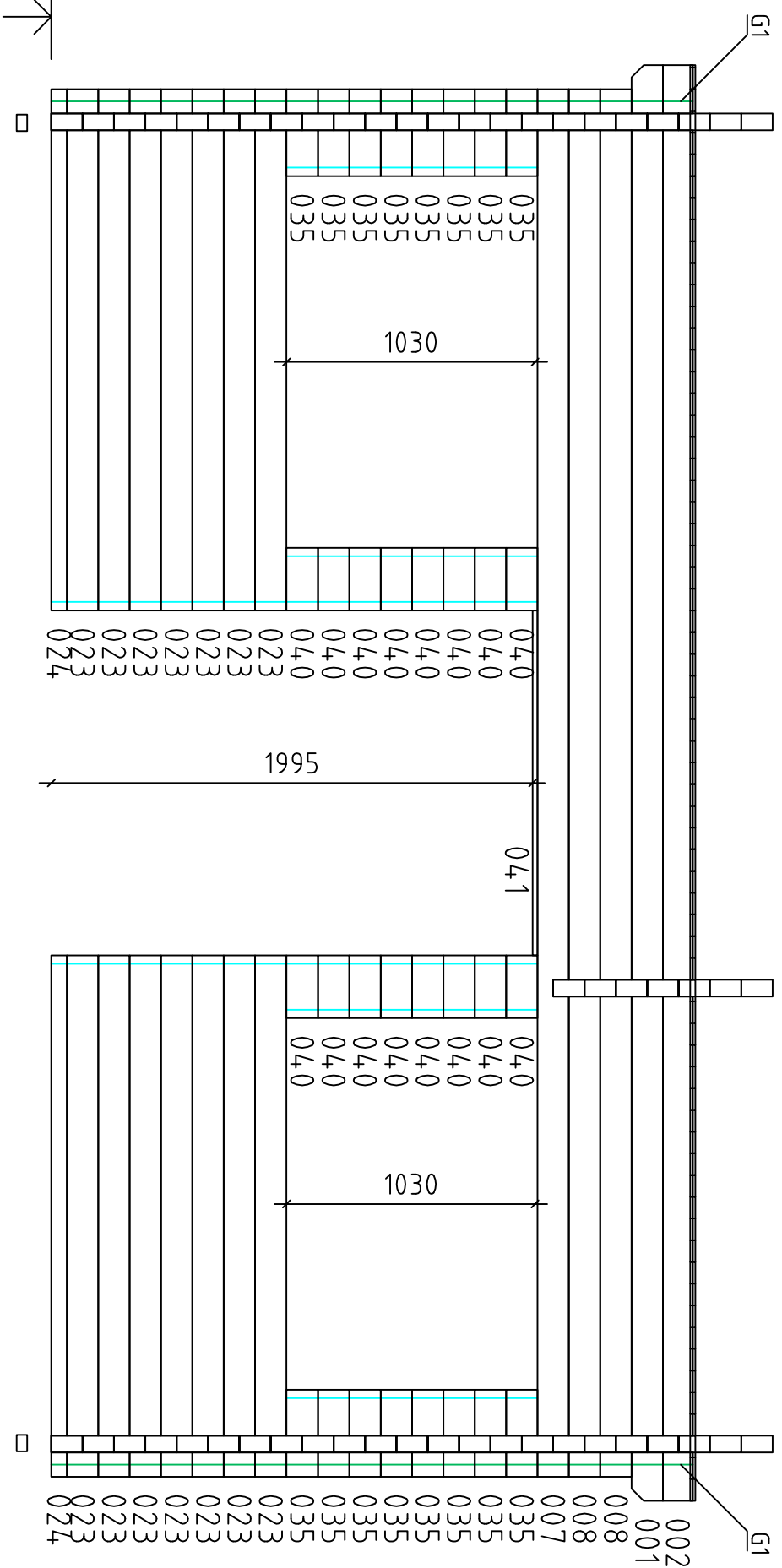

Richard//70/17

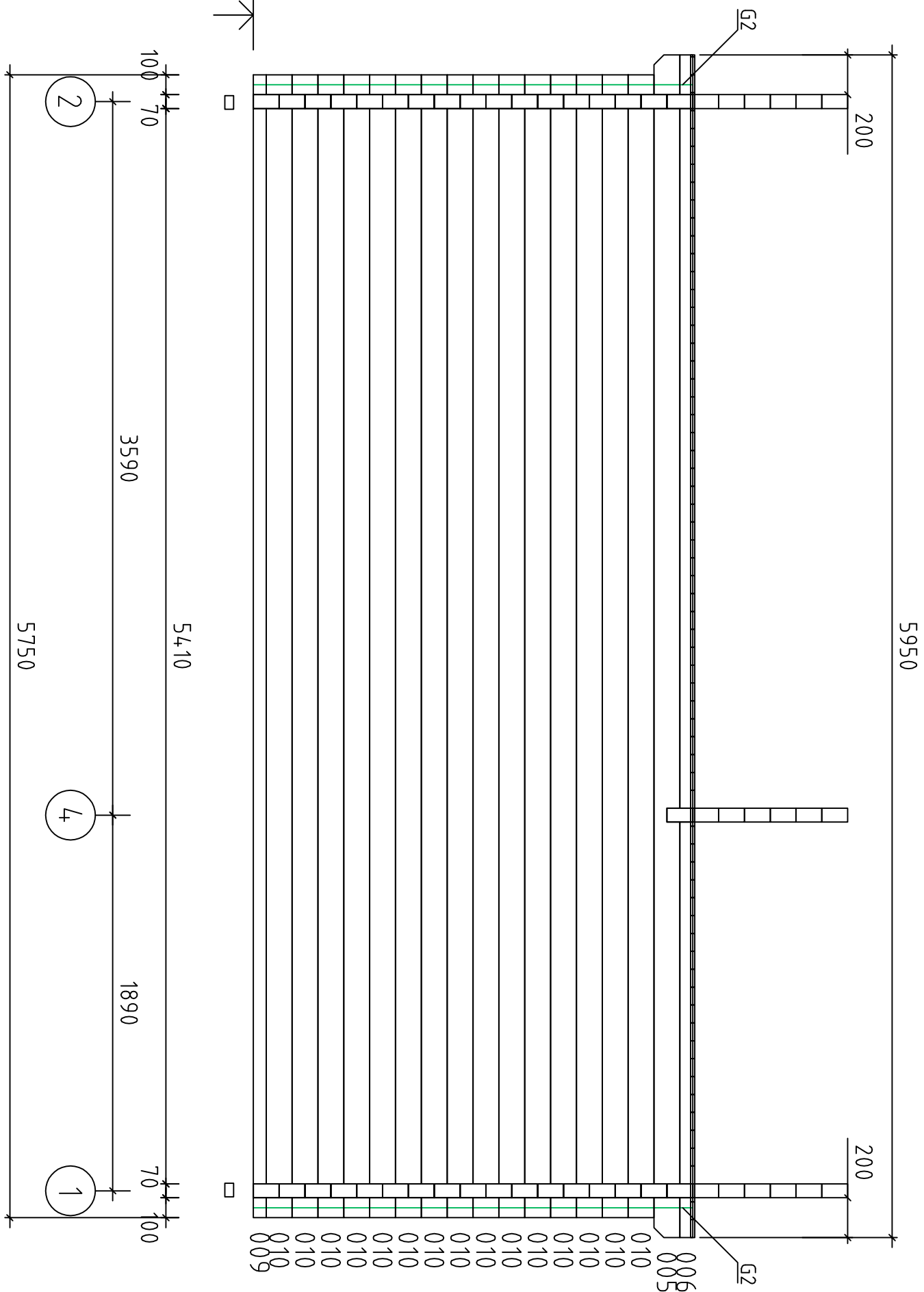

Richard//70/17

Wand 1 ↗

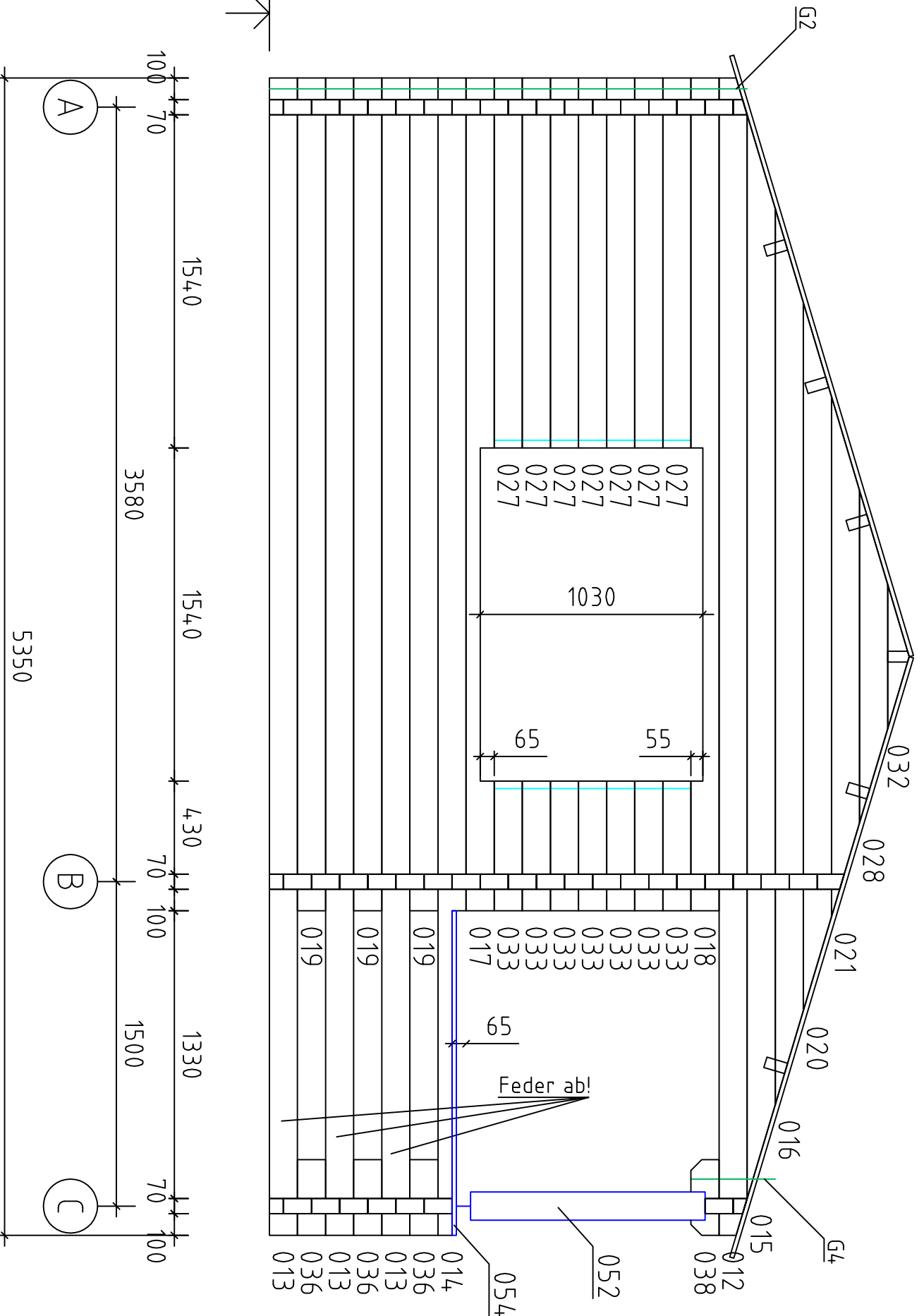

Richard//70/17

Wand 2 

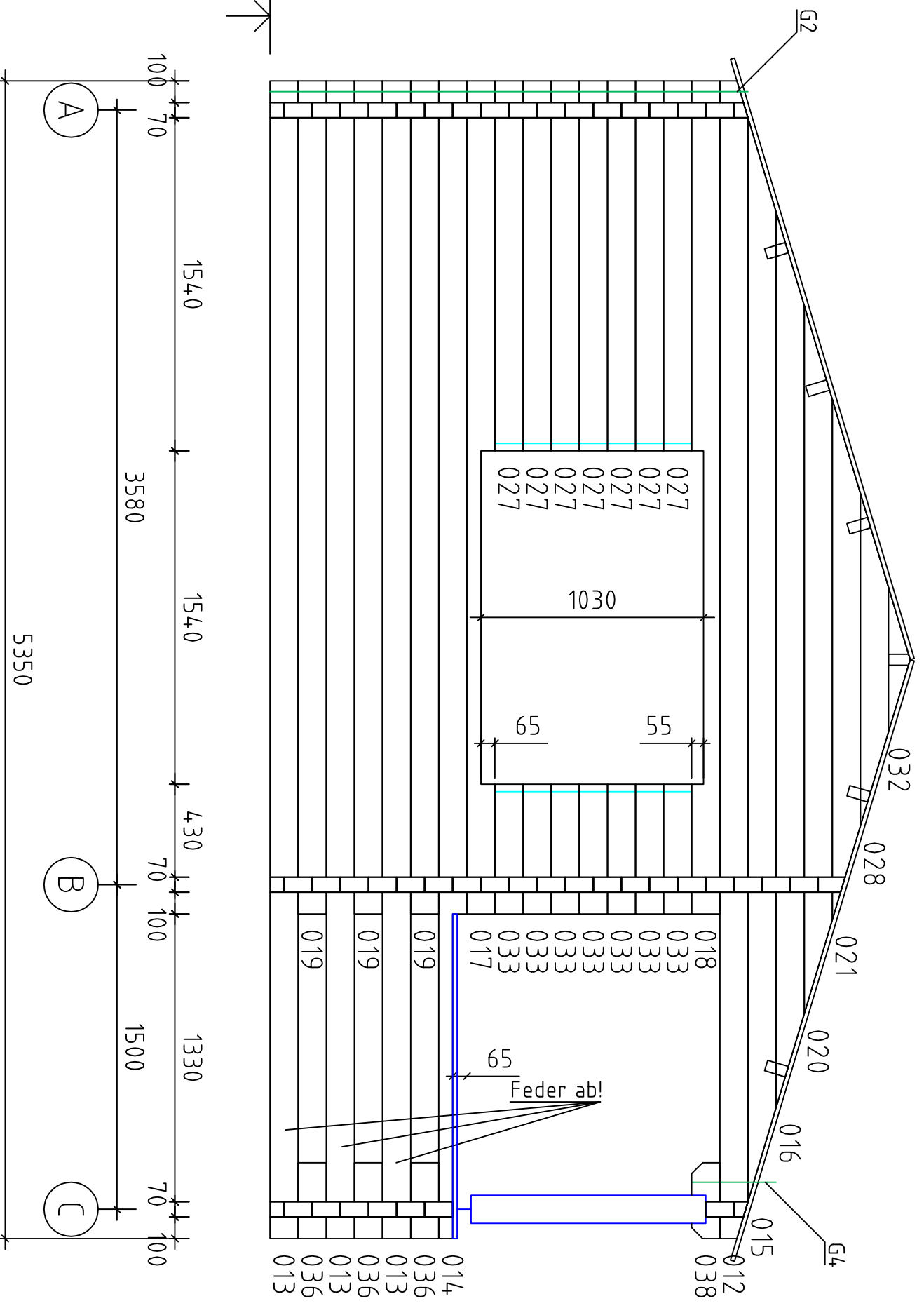



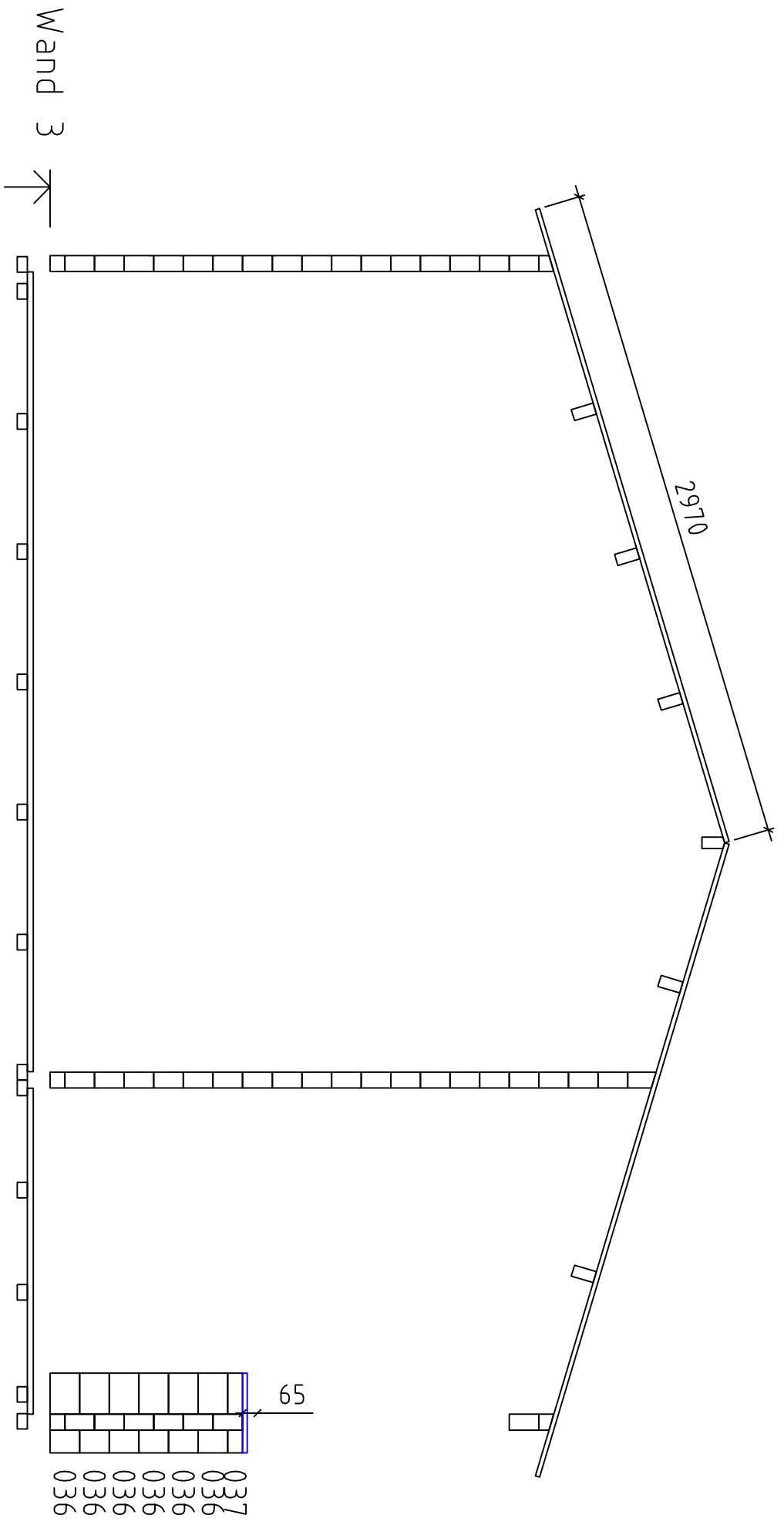



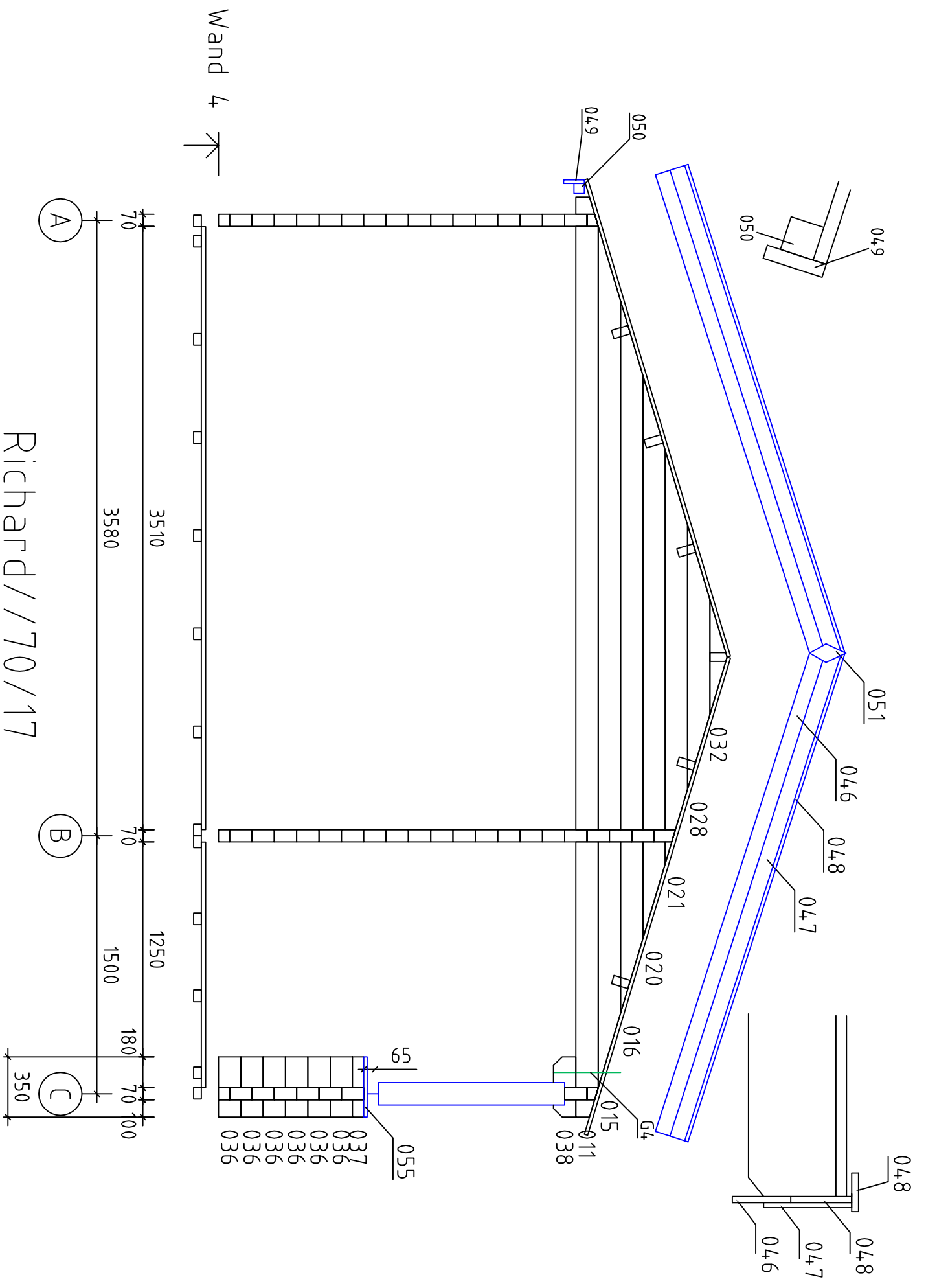



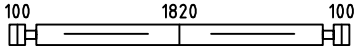
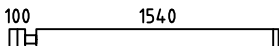
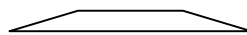
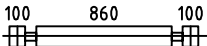
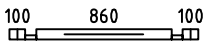
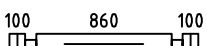
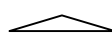
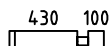

Richard//70/17









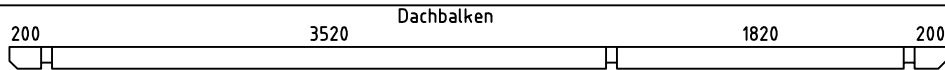
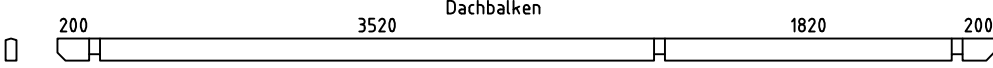

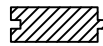
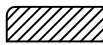
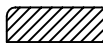
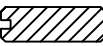



Richard//70/17

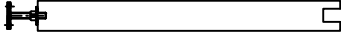

Pos	Richard//70/17	ST	F (mm)	L (mm)
001		1	70x130	5950
002		1	70x124	5950
003		1	70x130	5950
004		1	70x65	5950
005		1	70x130	5950
006		1	70x65	5950
007		1	70x130	5750
008		2	70x130	5750
009		1	70x65	5750
010		15	70x130	5750
011		1	70x130	5350
012		2	70x130	5350
013		6	70x130	5350
014		2	70x130	5350
015		3	70x130	5010
016		3	70x130	4142
017		2	70x130	3850
018		2	70x130	3850
019		6	70x130	3850
020		3	70x130	3273
021		3	70x130	2405
022		1	70x130	2160
023		14	70x130	2160
024		2	70x65	2160
025		1	70x65	2160

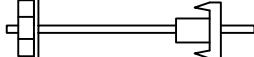
Pos	Richard//70/17	ST	F (mm)	L (mm)
026		2	70x130	2160
027		14	70x130	1710
028		3	70x130	1536
029		1	70x130	1200
030		1	70x65	1200
031		2	70x130	1200
032		3	70x100	668
033		14	70x130	600
034		3	70x130	400
035		16	70x130	360
036		18	70x130	350
037		2	70x65	350
038		3	70x130	350
039		12	70x130	350
040		16	70x130	260
041		1	70x20	1430
AR1	Fundamentbalken  Impr.	13	68x44	5404
AR2	Fundamentbalken  Impr.	2	68x44	5140
LM	Fundamentbalken  Impr.	11	68x68	5404
PR1	Dachbalken 	5	70x140	5950
PR2	Dachbalken 	1	70x140	5950

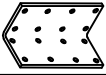
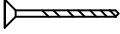
Pos	Richard//70/17		ST	F (mm)	L (mm)
042	Fussbodenbretter		61	90x26	3506
043	Terrassenbretter		Impr. 27	90x26	1498
	Terrassenbretter		Impr. 34	90x26	1428
044	Dachbretter		134	90x20	2970
045	Abdeckleiste			20x40	25m
046	Giebelbretter		4	20x120	3270
047	Giebelbretter		4	20x90	3270
048	Giebeldeckbretter		8	20x70	3270
049	Traufenbrett		4	20x90	3125
050	Traufenleiste		4	50x50	3125
051	Giebelsegment		2		
052	Pfosten		3	130x130	1085
053	Dübel		6		
054	Handlauf		2	20x90	1500
055			2	20x90	350
056			4	20x90	90
057			1	20x90	840
058			1	20x90	1800
G1	Gewindestift12		2		2690
G2			4		2205
G3			4		875
G4			3		315
G5			3		225

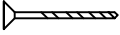
Pos	Richard//70/17		ST	F (mm)	L (mm)
KMPL.	Vinkel		20	40x40x40	
	Schrauben für Vinkel 4x40		160		
	Schrauben für Fundament 6x150		20		
	Nagel 2,5x60 (kül m ZN) (Fussboden und Dach)		4,5kg		
	Schrauben für Abdeckleiste 4x40		45		

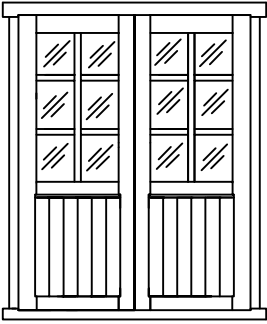
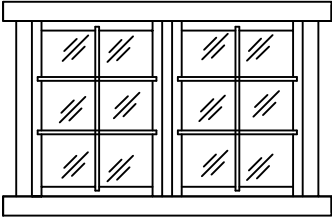
Pos	Richard//70/17	ST	F (mm)	L (mm)
T1	<p>Tür 1420x1955</p>  <p>Tenderleiste 23x23x1975=2st.</p>	1		
F2	<p>Fenster 1530x990</p>  <p>Tenderleiste 23x23x860=4st. Tenderleiste 23x23x990=4st.</p>	4		
Kood	Materjal	File	trükk.dwg	Leht 3/3